



A person in a dark suit stands with their back to the camera on the edge of a rocky cliff. They are looking out over a vast city skyline under a clear sky. The image is in a blue-tinted color palette.

Contents

01 Our Team

02 Group Companies

03 Partnerships

04 Activities

A person in a dark suit stands with their back to the camera on the edge of a rocky cliff. They are looking out over a vast city skyline under a clear sky. The image is in a blue-tinted color palette.

Contents

05 Production

06 Engineering

07 Product Groups

08 Main Sectors

A person in a dark suit stands with their back to the camera on the edge of a rocky cliff. They are looking out over a vast city skyline under a clear sky. The image is in a blue-tinted color palette.

Contents

09 Market Shares

10 Activity Overview

11 Test Facilities

12 Quality Assurance

A person in a dark suit stands with their back to the camera on the edge of a rocky cliff. They are looking out over a vast city skyline under a clear sky. The image is in a blue-tinted color palette.

Contents

13 Wacker Chemie AG

14 Management System Certifications

15 More from SolPro

15 Contact

Our Team

Dr. Ing. Metin Savaskan

Ms. Elif Ebru Artar

Ms. Emine Gümüő

Mr. Akın Gürbüz



Director

+90 532 504 55 45

msavaskan@solpro-tr.com

Project Manager

+90 216 378 79 80

eartar@solpro-tr.com

Customer Service

+90 216 378 79 80

egumus@solpro-tr.com

Accounting

+90 216 378 79 80

agurbuzer@solpro-tr.com

Companies

01 SolPro



02 Plastiks



03 Inoser



04 BeVes



05 Savas



06 MayaTech



Partnerships

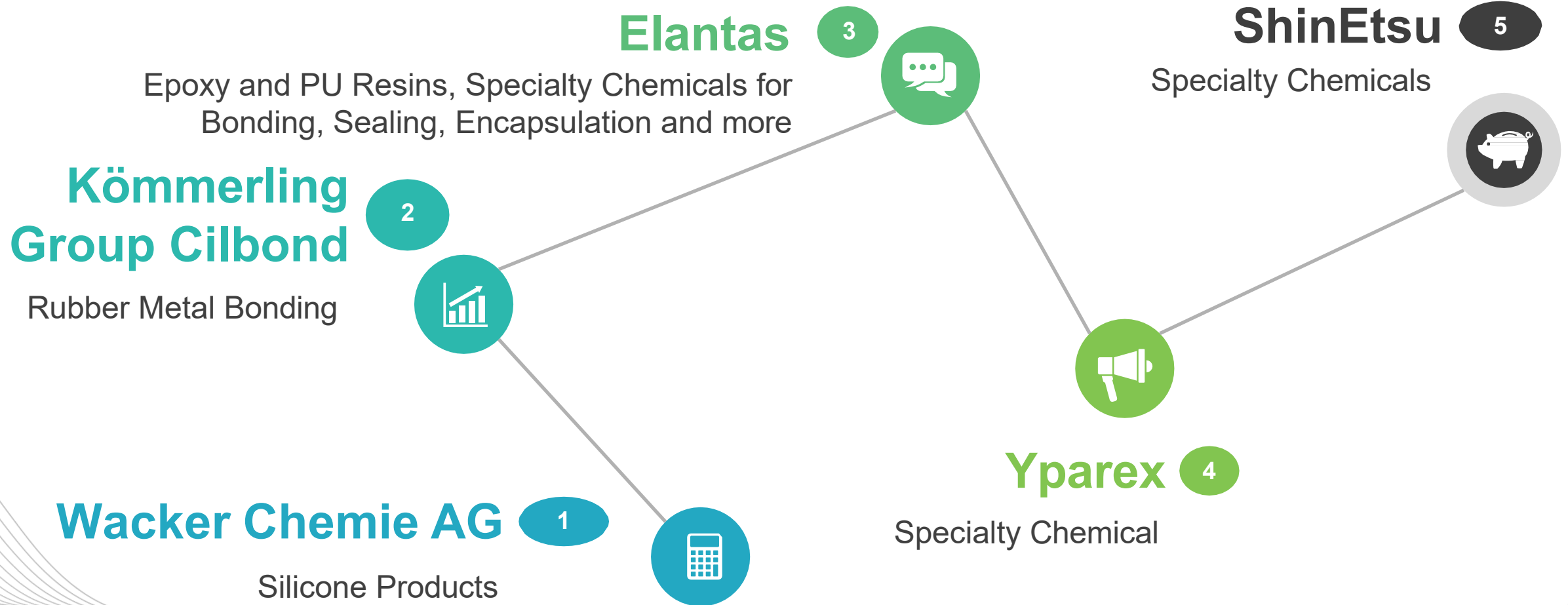

- ✓ High Performance Elastomer Compounding
- ✓ Silicone Rubber based products (profiles, sealing elements, molded articles etc.)
- ✓ Distribution of High Performance Chemicals and Specialties
- ✓ High Performance Elastomers like FVMQ, FKM, ACM, AEM, HNBR, ECO, vs.



- ✓ Standard Elastomers like EPDM, NBR, NR etc. for specific applications
- ✓ Application Oriented Materials and Process Development
- ✓ System Development
- ✓ Business Development
- ✓ Consulting

Activities

inoser®

We develop solutions!

Production Facilities



Engineering

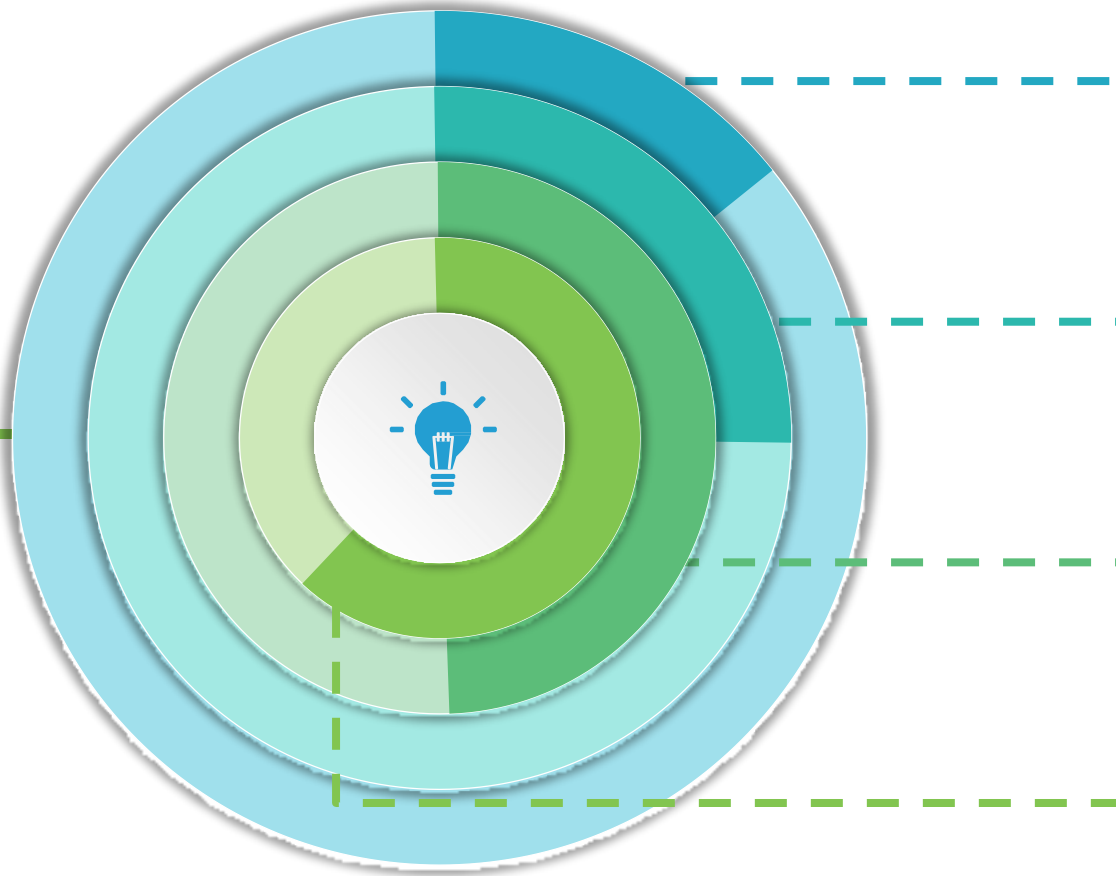

Testing

Mechanical, physical, chemical, electrical test and more



Prototyping

Developing samples for functional tests



Product Development

Cutting Edge Solution for Challenges



Design

Solution Development

Product Groups



Special Compounds

Compounding of High Performance Elastomers

VMQ, FKM, HNBR, PUR, FFKM, FVMQ, NBR, EPDM and more



Rubber Metal Bonding

Solving Bonding Issues

Cilbond Bonding Agents



LSR, RTV1, RTV2 and further Specialties

Molded Parts, Bonding, Sealing, Coating and more

Wacker Chemie AG Specialties



Epoxy and PU Resins

For various application from molding to encapsulation, sealing, bonding etc.

Elantas Product Group

Main Sectors

White Goods

Ovens, Refrigerators,
Dishwasher, Washing
Machines and more



Construction

Profiles, Sealants,
Adhesives and more

Automotive and Mobility

Sealing, Damping, Hoses
and more



Medical

Hoses, Molded Parts and
more

Wire and Cable

High Temperature
Resistance, Flame and Fire
Resistancy



Main Sectors

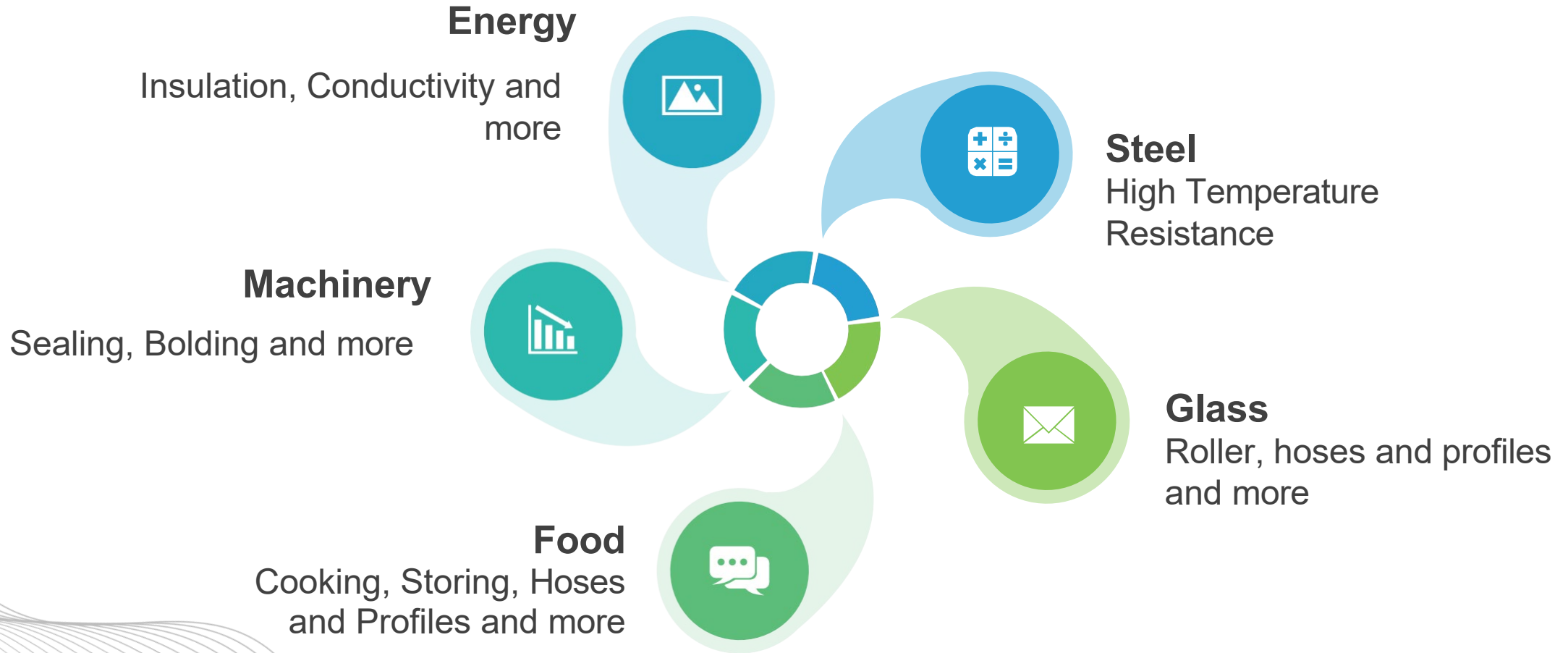



%40-90 at Main Sectors

**Leadership in product
Groups**

Market Shares

- ✓ SolPro is dedicated to work in specialty applications
- ✓ SolPro differentiates from competitors and markets by focusing on added value to the business
- ✓ SolPro concentrates on achievable nish markets and competitiveness
- ✓ SolPro enables achieving high market shares at achievable markets

Activity Overview

Compounding
Compounding of High
Performance Elastomers

Test and Certification
Meeting market expectations
in terms of standards and
directives

Preforms
Supplying in customized
preforms

Logistics
Speed and Flexibility

Post Curing
Focusing on critical process
steps like post curing

Regional Presence
Locality mean closeness to
customers and markets



Activity Overview

Product Development

Defining and refining requirements

Lab Activities

Control, verification and validation

Design

Product and Process Design

Finished Products

From Prototyping to Pre-series and Serial Production
Support of Finished Products

Process Development

Defining and implementing critical process parameters and enabling competitive processing

Cost Down

Developing Cost Down Project through Output and Efficiency Increase and Re-Engineering



Test Facilities

Mechanical Tests

Tensile, Elongation, Tear, Compression, Abrasion, Rebound and more

Electrical tests

Conductivity, High Voltage, Resistivity and more

Digital Visualisation

Controls via Digital Video System

Dimensions

Dimension Controls

Chemical Tests

PAH, RoHS, Reach, ELV and further chemical restrictions are strictly followed

Physical Tests

TGI, FT-IR, DSC etc.

 Ensuring Quality

Test Facilities

 **Visual Controls**
various

 **Food Contacts**
LFGB, FDA, BfR, NF etc.

 **Medical**
Biocompatibility, USP Class

 **Cooperation with External Labs**
Testing, Inspection and Certification by independent 3rd Parties

 **Functional Checks**
Functionality Control up to customer and industrial specifications

 **Further Tests**
Fire and Flam Retardancy Tests and more

 **Ensuring Quality**

Quality Assurance

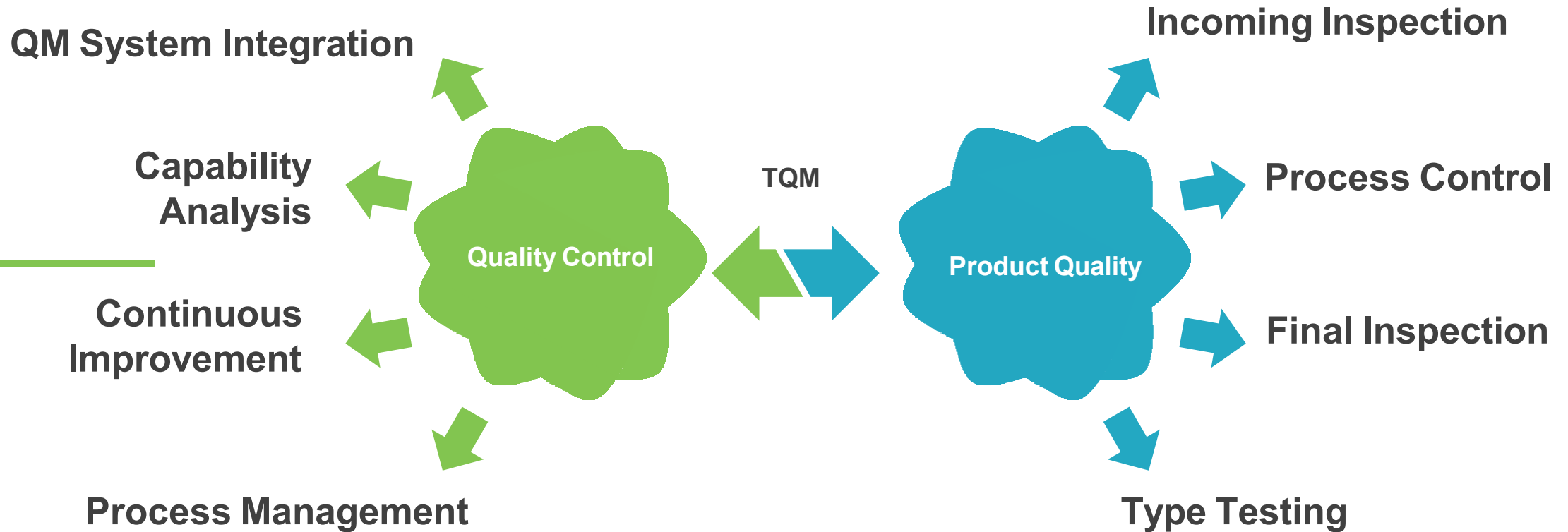

Wacker Chemie AG

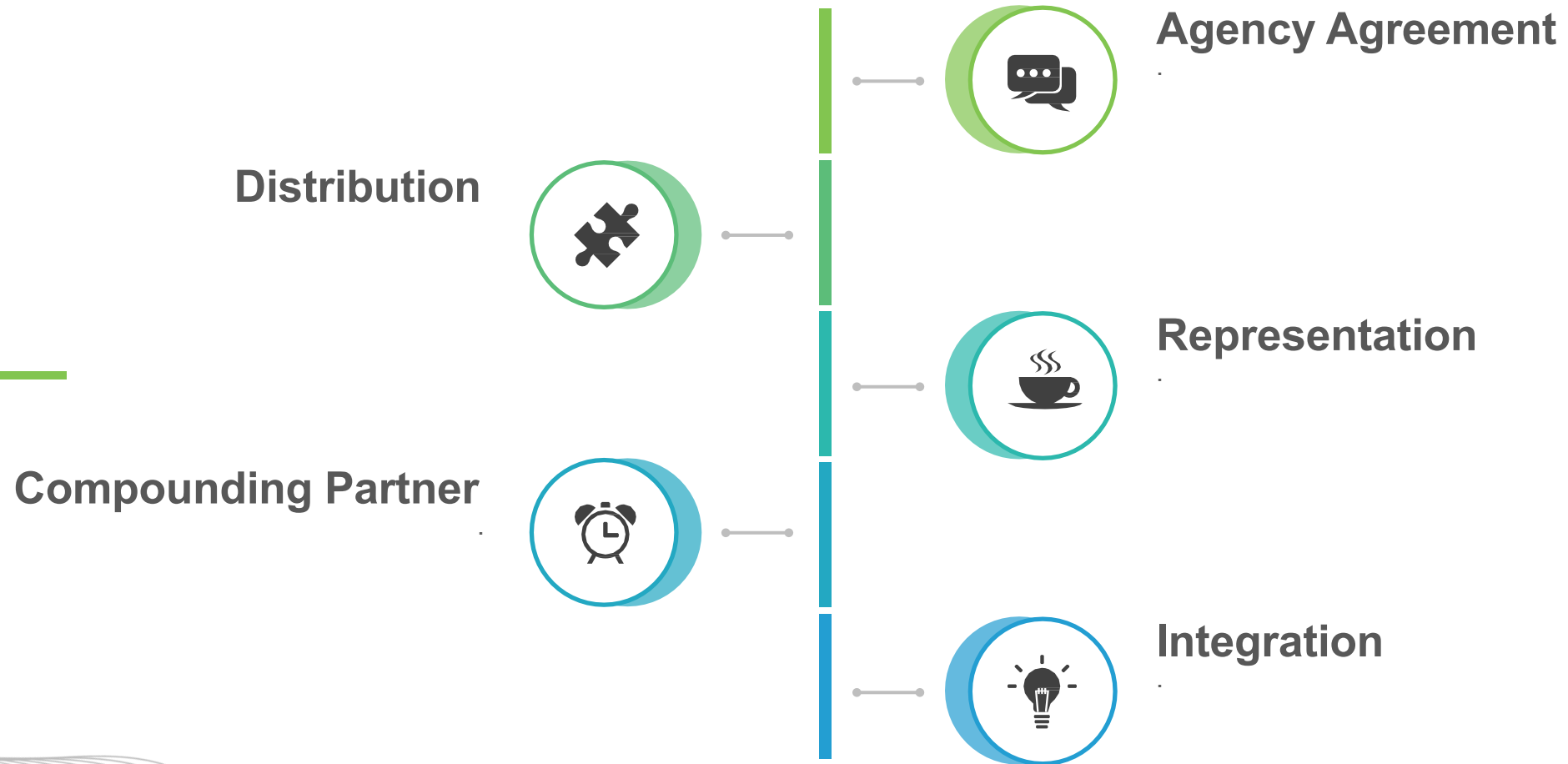

Wacker Partner Compounder

PRESS RELEASE

Wacker Chemie AG
Hanns-Seidel-Platz 4
81737 München, Germany
www.wacker.com

Number

44

WACKER Entrusts Silicone Compounding to its Turkish Sales Partner SOLPRO

Munich, September 21, 2011 – WACKER, the Munich-based chemicals Group, is expanding its cooperation with the Turkish silicone compounder and distributor SOLPRO Ltd.. The two companies signed an agreement to that effect in mid-September. Accordingly, SOLPRO, besides handling sales of high (HTV) and room (RTV) temperature vulcanizing silicones, will take over the compounding of custom silicones for the Turkish market with immediate effect. The ready-to-use compounds will be sold under WACKER's proprietary "Based on ELASTOSIL®" label. The compounds are targeted at customers in the automotive, construction, electronics, cables and household appliance industries.

"Turkey has been an important growth market for WACKER for many years. We are ideally positioned here in solid and RTV silicone resins," said Dr. Bernd Pachaly, head of the Engineering Silicones business unit, at the contract signing in Istanbul. He pointed out that the company now wants to systematically improve sales of silicone compounds in the region. "However, production of compounds is difficult and requires a good deal of experience," Pachaly continued. "Our customers expect short lead times, high flexibility and a consistently high quality. In SOLPRO, we have an experienced partner who thoroughly understands the market and has the expertise and equipment to produce high-quality silicone compounds. This



arrangement will allow us to serve our customers in Turkey even better than before."

SOLPRO's proprietor, Dr. Metin Savaskan, acknowledged the agreement as an important milestone in his cooperation with the Munich-based chemicals Group. "We are already responsible for selling WACKER silicones elastomers in Turkey. Now, we will also be able to produce ready-to-use custom products from WACKER's silicone-rubber base materials. That opens up entirely new markets and ways of meeting our customers' needs."

“



”

Wacker Distributor

Official Distributor of Wacker Chemie AG

WACKER

Wacker Chemie AG
Hanns-Seidel-Platz 4
81737 München, Germany
www.wacker.com

PRESS RELEASE

Number 20

WACKER Reorganizes Turkish Distribution of Silicone Elastomers

Munich, July 3, 2009 – WACKER, the Munich-based chemical group, is restructuring its silicone elastomer distribution in Turkey. Starting September 1, SolPro, a silicones distributor, will be selling not only WACKER's solid silicone rubbers but also the ELASTOSIL® M brand of RTV-2 Silicones. These are cold-curing, two component silicones made especially for use in mold making and rapid prototyping. The Istanbul-based silicone supplier will take over the distribution of this product portfolio from ULTRAKIM, WACKER's previous sales distributor for these products in the region.

For some years now, SolPro has been a sales partner in Turkey for ELASTOSIL® solid silicone rubbers. These heat-curing silicones are used, for example, for fireproof cables, seals, profiles and O-rings. "So far, our cooperation with SolPro has been extremely good. The company has in-depth expertise in elastomers and has earned an excellent reputation as a silicone supplier," said Dr. Bernd Pachaly, head of the Elastomers business unit, while explaining the decision. "While reorganizing our sales channels, we decided to entrust SolPro

“

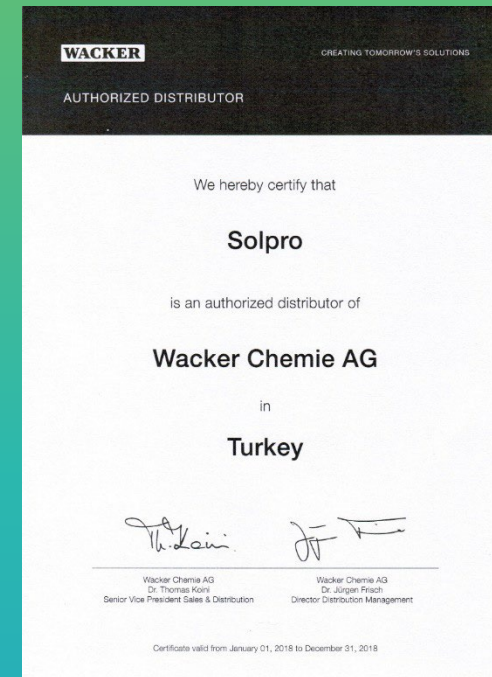

”

Management System Certifications



ISO 9001
Quality Management
System Certification



ISO 14001
Environmental
Management System
Certification



IATF 16949
Automotive Quality
Management System
Certification

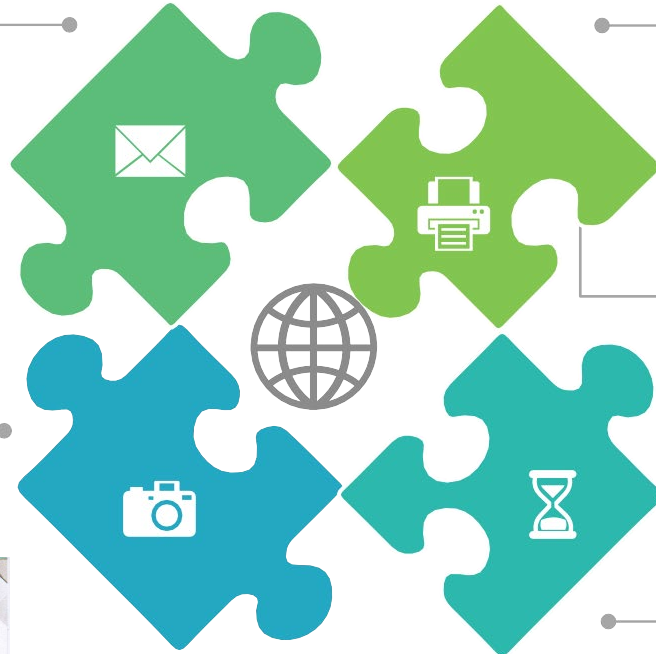

ISO 27001
Information Security
Management System
Certification



ISO 10002
Environmental
Management System
Certification



ISO 45001
Occupational Health and
Safety Management
System Certification



MORE FROM SolPro

Applications, Sector, Offering



Advantages

- Gaskets that can be used with or without clips
- Assembled or unassembled parts and profiles in different lengths

- Cost-effective product preparation
- Product preparation for open and closed frames



Please ask for our
leaflets and brochures
for specific
applications and
sectors!

info@solpro-tr.com

SolPro Ltd. Sti.

Contact Us



SolPro Danışmanlık Kimya Sanayi
ve Ticaret Limited Şirketi



Kaynarca Cad. No:48 Pendik
34906 İstanbul Turkey



+90 216 378 79 80
+90 532 504 55 45



info@solpro-tr.com



A photograph of a city skyline, likely New York City, viewed through the opening of a dark cave. The scene is dimly lit, with the city lights and buildings visible through the natural light coming from the opening. The cave walls are dark and textured.

Thank You

SolPro Ltd. Sti.

A decorative horizontal bar at the bottom of the slide, consisting of three segments: a light green segment on the left, a teal segment in the middle, and a light blue segment on the right.A large decorative horizontal bar spanning the width of the slide, with a gradient from light green on the left to light blue on the right.

Flyer Medical

Official Partner of Wacker Chemie AG

sol pro
Solution Provider

High Performance Elastomers
Your Solution Partner!

inoser
www.solpro-tr.com

Our Company SolPro, which is one of the biggest manufacturers of its fields Europe, has been giving consultancy and engineering services regarding production process and raw materials in various industries, and has been manufacturing tailor made products according to the specific needs of different industries for more than 15 years.

SolPro is the agent, distributor and the Partner Compounder of Wacker Chemie AG of Germany, besides it is the regional distributor for Engel and Kötterling / Polycyl / Cilbond products.

For various industrial sectors, our company is able to support you with its wide product range and technical capacity in order to help you to choose the right materials for your production process and to develop value-added products, and will be pleased to serve you with the silicon-based finished products that we are producing and introducing as well.

Materials for Medical Industry

- "Pure" Materials
- Up-to-date Health Care Certificates
- Regulatory Issues
- Ionic and micro-contamination prevention
- Heat resistance between -100 °C – + 300 °C according to the type of product used
- No organic stabilizers, plasticizers or softeners
- Sterilizable, Biocompatible, No Allergies
- 50 micron filtering and protective packing

Usage Areas

- Health Care
- Orthopedics, Prosthetics
- Diagnostics
- Wound Care
- And more...

Main Products and Services

- Tubes, Hoses, Sealing, Valves, Plugs, Stoppers
- Face Masks
- Bellows
- Catheter Balloon
- Handles for Surgical Instruments
- Catheter Hoses
- Tracheal Tubes
- Breathing Tubes, Pressure Hoses
- Sealing Profiles, Shunts and Drainage Systems

Advantages

- Hydrophobic surface repels water and dirt,
- Thermal, chemical and physical resistance without stabilizers
- Resistance for a long time to low and elevated temperatures and sterilizable
- Batch related quality release and enhances protective packing
- Resistant to media usually used in medical applications, Hypoallergenic
- Easy to clean even with diluted acids like acetic acid
- Steam sterilizable in autoclaves, Dishwasher resistant
- Safe in use, do not melt, promote fire, impact resistant
- High Level of transparency and colorability, Available in wide range of hardness
- Good resistance to UV radiation and X-Rays



“

WACKER CREATING TOMORROW'S SOLUTIONS

PARTNER COMPOUNDER OF WACKER CHEMIE AG

September 16, 2011

SOLPRO Danışmanlık Kimya Sanayi Tic. Ltd. Şti.

signed a
Partnership Agreement

with
Wacker Chemie AG

to produce and sell high-quality compounds of high temperature vulcanizing silicones and is entitled to label them "Based on ELASTOSIL™".

ELASTOSIL™
is a registered trademark of Wacker Chemie AG

Andreas
Dr. Bernd Pachatz
Vice President
Engineering Silicones

Axel
Axel Schmitt
Director Rubber Solutions
Engineering Silicones

WACKER
September 16, 2011

”

Our Company SolPro, which is one of the biggest manufacturers of its field in Europe, has been giving consultancy and engineering services regarding production process and raw materials in various industries, and has been manufacturing tailor made products according to the specific needs of different industries for more than 15 years.

SolPro is the agent, distributor and the Partner Compounder of Wacker Chemie AG of Germany; besides it is the regional distributor for Elastas and Kömmerling / Polycil / Cilbond products.

For various industrial sectors, our company is able to support you with its wide product range and technical capacity in order to help you to choose the right materials for your production process and to develop value-added products, and will be pleased to serve you with the silicon-based finished products that we are producing and introducing as well.

Materials for Medical Industry

- "Pure" Materials
- Up-to-date Health Care Certificates
- Regulatory Issues
- Ionic and micro-contamination prevention
- Heat resistance between -100 °C ~ + 300 °C according to the type of product used
- No organic stabilizers, plasticizers or softeners
- Sterilizable, Biocompatible, No Allergies
- 50 micron filtering and protective packing

Usage Areas

- Health Care
- Orthopedics, Prosthetics
- Diagnostics
- Wound Care
- And more...

Main Products and Services

- Tubes, Hoses, Sealing, Valves, Plugs, Stoppers
- Face Masks
- Bellows
- Catheter Balloon
- Handles for Surgical Instruments
- Catheter Hoses
- Tracheal Tubes
- Breathing Tubes, Pressure Hoses
- Sealing Profiles, Shunts and Drainage Systems

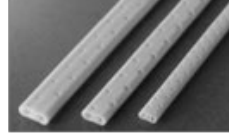

Advantages

- Hydrophobic surface repels water and dirt,
- Thermal, chemical and physical resistance without stabilizers
- Resistance for a long time to low and elevated temperatures and sterilizable
- Batch related quality release and enhances protective packing
- Resistant to media usually used in medical applications, Hypoallergenic
- Easy to clean even with diluted acids like acetic acid
- Steam sterilizable in autoclaves, Dishwasher resistant
- Safe in use, do not melt, promote fire, impact resistant
- High Level of transparency and colorability, Available in wide range of hardness
- Good resistance to UV radiation and X-Rays



Approvals

Please see the documentation for the approvals required for the sector and the area of use and request detailed information about our products.

- REACH
- RoHS
- CE
- UL 94- V0/V1
- ISO 10993, 93/42/EC Directive
- USP Class VI
- Etc...

Laboratory Infrastructure

In our laboratory; we have the capability to test;

- Electrical (insulation resistance, conductivity, high voltage, etc.) properties,
- Mechanical (tensile-rupture, hardness, permanent deformation, etc.) properties,
- Physical (rheometer, viscosity, geometric measurements) Before and After extensive Analysis,
- Different aging,
- Flame resistance,
- And many other tests, thanks to our experienced staff and extensive portfolio of test equipment.

Technical Support

Product development:
If you have a product that you want to produce, but you have difficulty in Choosing raw materials,

Technical Specs:
If you have a critical technical specification or specification,

Process:
If you have problems with molding, injection, extrusion, autoclave, calendaring or whatever process you want, and want to increase your productivity,

Standards and Certification
If the sectors you are addressing and your customers require compliance and certification to certain standards,

Continuity in Quality:
If you have mechanical, physical, chemical or only constant color expectations, if you have difficulty in obtaining the desired quality and specifications,

Product and Market Development:
New openings for or company if you are looking for new products, new processes and new markets



Flyer Energy

Official Partner of Wacker Chemie AG

sol pro
Solution Provider

High Performance Elastomers
Your Solution Partner!

inoser
www.solpro-tr.com

Our Company SolPro, which is one of the biggest manufacturers of its field in Europe, has been giving consultancy and engineering services regarding production process and raw materials in various industries, and has been manufacturing tailor made products according to the specific needs of different industries for more than 15 years.

SolPro is the agent, distributor and the Partner Compounder of Wacker Chemie AG of Germany; besides it is the regional distributor for Elantas and Kömmerling / Polycyl / Citbond products.

For various industrial sectors, our company is able to support you with its wide product range and technical capacity in order to help you to choose the right materials for your production process and to develop value-added products, and will be pleased to serve you with the silicon-based finished products that we are producing and introducing as well.



Transformer, Insulator, Switchgear, Bushing, etc...

- Prevents the formation of toxic fumes or by-products in case of fire
- Applicable in fields that require fire resistance
- Easy set-up and reduction in operation time of maintenance
- Applicable in damp and dirty environments
- Dielectric insulating material for transformers and insulators

Advantages

- High adhesion and mechanical resistance
- Electrical Insulation
- Flame Retardant
- Prevents electric arc due to dust-free structure
- Facilitates production with processable filling rates.

Fields of Application

- Medium, High Voltage Indoor and Outdoor Transformers
- Insulators,
- Circuit Breakers,
- Switchgears,
- Bushings,
- And such electric insulation equipments...

Main Products and Services

- Casting resins with high mechanical strength for dry type transformer and windings
- Resins specially designed for insulators and bushings.



“



”

Our Company SolPro, which is one of the biggest manufacturers of its field in Europe, has been giving consultancy and engineering services regarding production process and raw materials in various industries, and has been manufacturing tailor made products according to the specific needs of different industries for more than 15 years.

SolPro is the agent, distributor and the Partner Compounder of Wacker Chemie AG of Germany; besides it is the regional distributor for Elantas and Kömmerling / Polycil / Cilbond products.

For various industrial sectors, our company is able to support you with its wide product range and technical capacity in order to help you to choose the right materials for your production process and to develop value-added products, and will be pleased to serve you with the silicon-based finished products that we are producing and introducing as well.



Transformer, Insulator, Switchgear, Bushing, etc...

- Prevents the formation of toxic fumes or by-products in case of fire
- Applicable in fields that require fire resistance
- Easy set-up and reduction in operation time of maintenance
- Applicable in damp and dirty environments
- Dielectric insulating material for transformers and insulators

Fields of Application

- Medium, High Voltage Indoor and Outdoor Transformers
- Insulators,
- Circuit Breakers,
- Switchgears,
- Bushings,
- And such electric insulation equipments...

Main Products and Services

- Casting resins with high mechanical strength for dry type transformer and windings
- Resins specially designed for insulators and bushings.



Advantages

- High adhesion and mechanical resistance
- Electrical Insulation
- Flame Retardant
- Prevents electric arc due to dust-free structure
- Facilitates production with processable filling rates.



Approvals

Please see the documentation for the approvals required for the sector and the area of use and request detailed information about our products.

- REACH
- RoHS
- CE
- UL 94- V0/V1
- And different approvals upon request...



Laboratory Infrastructure

In our laboratory; we have the capability to test;

- Electrical (insulation resistance, conductivity, high voltage, etc.) properties,
- Mechanical (tensile-rupture, hardness, permanent deformation, etc.) properties,
- Physical (rheometer, viscosity, geometric measurements) Before and After extensive Analysis,
- Different aging,
- Flame resistance,
- And many other tests, thanks to our experienced staff and extensive portfolio of test equipment.



Technical Support

Product Development:

If you have a product that you want to produce, but you have difficulty in Choosing raw materials,

Technical Specs:

If you have a critical technical specification or specification,

Process:

If you have problems with molding, injection, extrusion, autoclave, calendaring or whatever process you want, and want to increase your productivity,

Standards and Certification:

If the sectors you are addressing and your customers require compliance and certification to certain standards,

Continuity in Quality:

If you have mechanical, physical, chemical or only constant color expectations, if you have difficulty in obtaining the desired quality and specifications,

Product and Market Development:

New openings for or company if you are looking for new products, new processes and new markets.



Flyer Sealing

Official Partner of Wacker Chemie AG

sol pro
Solution Provider

GASKETS & SEALS

inoser
www.sol-pro-tr.com

Our Company SolPro, which is one of the biggest manufacturers of its field in Europe, has been giving consultancy and engineering services regarding production process and raw materials in various industries, and has been manufacturing tailor made products according to the specific needs of different industries for more than 15 years.

SolPro is the agent, distributor and the Partner Compounder of Wacker Chemie AG of Germany, besides it is the regional distributor for Elantas and Kömmerling / Polycol / Clibond products.

For various industrial sectors, our company is able to support you with its wide product range and technical capacity in order to help you to choose the right materials for your production process and to develop value-added products, and will be pleased to serve you with the silicon-based finished products that we are producing and introducing as well.



Sealing Elements

- Applied as seal between static and dynamic machine parts,
- Plays an important role on the operational performance of the systems,
- Durability of the high cost parts in the machines varies depending on the quality of the seals used,
- Prices of these sealing elements are much lower than the prices of machinery and equipment, but in fact their quality makes big difference,
- Can be used in fields where exposed to high speed and high friction,
- Resistant to mineral oils, fireproof hydraulic oils, different temperature, water and fluids
- Electrical insulating, heat resistant, fire proof, dirt repelling, and resistant to such external factors



Fields of Application

- Machinery Industry
- Industrial Spare Parts
- Automotive
- Aviation
- White Goods
- Defense Industry
- Sanitaryware
- Etc. Use in Industries

Main Products and Services

VMO, FKM, EPDM, NBR, NR, P.V.M.Q. etc. Rubber Based;

- Cylinder Head Gasket
- Felt Types
- Diaphragms and Valves
- O-ring, U-ring, V-rings
- Insulation Seals and Profiles
- Vibration Pads and Buffers
- Industrial Adhesives
- Such products for different applications



Advantages

- Selection of suitable raw materials acc. to specific application type
- Product types suitable for working conditions
- Shore Strength adjustment according to product
- Cost-effective product preparation

“

WACKER CREATING TOMORROW'S SOLUTIONS

PARTNER COMPOUNDER OF WACKER CHEMIE AG

September 16, 2011

SOLPRO
Danışmanlık Kimya
Sanayi Tic. Ltd. Şti.

signed a
Partnership Agreement

with
Wacker Chemie AG

to produce and sell high-quality compounds of high temperature vulcanizing silicones and is entitled to label them "Based on ELASTOSIL™".

ELASTOSIL™
A WACKER CHEMIE AG BRAND

Arslan
Dr. Bernd Pachatz
Vice President
Engineering Silicones

Axel Schmitt
Director Rubber Solutions
Engineering Silicones

Valid until December 31, 2014

”

Our Company SolPro, which is one of the biggest manufacturers of its field in Europe, has been giving consultancy and engineering services regarding production process and raw materials in various industries, and has been manufacturing tailor made products according to the specific needs of different industries for more than 15 years.

SolPro is the agent, distributor and the Partner Compounder of Wacker Chemie AG of Germany; besides it is the regional distributor for Elantas and Kömmerling / Polycoil / Cilbond products.

For various industrial sectors, our company is able to support you with its wide product range and technical capacity in order to help you to choose the right materials for your production process and to develop value-added products, and will be pleased to serve you with the silicon-based finished products that we are producing and introducing as well.



Sealing Elements

- Applied as seal between static and dynamic machine parts,
- Plays an important role on the operational performance of the systems,
- Durability of the high cost parts in the machines varies depending on the quality of the seals used,
- Prices of these sealing elements are much lower than the prices of machinery and equipment, but in fact their quality makes big difference,
- Can be used in fields where exposed to high speed and high friction,
- Resistant to mineral oils, fireproof hydraulic oils, different temperature, water and fluids
- Electrical insulating, heat resistant, fire proof, dirt repelling, and resistant to such external factors

Fields of Application

- Machinery Industry
- Industrial Spare Parts
- Automotive
- Aviation
- White Goods
- Defense Industry
- Sanitaryware
- Etc. Use In Industries

Main Products and Services

VMQ, FKM, EPDM, NBR, NR, FVMQ etc. Rubber Based;

- Cylinder Head Gasket
- Felt Types
- Diaphragms, and Valves
- O-ring, U-ring, V-rings
- Insulation Seals and Profiles
- Vibration Pads and Buffers
- Industrial Adhesives
- Such products for different applications



Advantages

- Selection of suitable raw materials acc. to specific application type
- Product types suitable for working conditions
- Shore Strength adjustment according to product
- Cost-effective product preparation



Approvals

Please see the documentation for the approvals for the sector and the area of use and request detailed information about our products.

- REACH Compliance
- RoHS Compliance
- CE Declaration
- FDA Declaration
- BFR Declaration
- And different approvals upon request



Laboratory Infrastructure

In our laboratory; we have the capability to test;

- Electrical (insulation resistance, conductivity, high voltage, etc.) properties,
- Mechanical (tensile-rupture, hardness, permanent deformation, etc.) properties,
- Physical (rheometer, viscosity, geometric measurements) Before and After extensive Analysis,
- Different aging,
- Flame resistance,
- And many other tests, thanks to our experienced staff and extensive portfolio of test equipment.



Technical Support

Product Development:

If you have a product that you want to produce, but you have difficulty in Choosing raw materials,

Technical Specs:

If you have a critical technical specification or specification,

Process:

If you have problems with molding, injection, extrusion, autoclave, calendaring or whatever process you want, and want to increase your productivity,

Standards and Certification:

If the sectors you are addressing and your customers require compliance and certification to certain standards,

Continuity in Quality:

If you have mechanical, physical, chemical or only constant color expectations, if you have difficulty in obtaining the desired quality and specifications,

Product and Market Development:

New openings for or company if you are looking for new products, new processes and new markets.



Flyer Electronic

Official Partner of Wacker Chemie AG

sol pro
Solution Provider

High Performance Elastomers
Your Solution Partner!

inoser
www.solpro-tr.com

Our Company SolPro, which is one of the biggest manufacturers of its field in Europe, has been giving consultancy and engineering services regarding production process and raw materials in various industries, and has been manufacturing tailor made products according to the specific needs of different industries for more than 15 years.

SolPro is the agent, distributor and the Partner Compounder of Wacker Chemie AG of Germany, besides it is the regional distributor for Elantas and Kömmerling / Polycyl / Cilbond products.

For various industrial sectors, our company is able to support you with its wide product range and technical capacity in order to help you to choose the right materials for your production process and to develop value-added products, and will be pleased to serve you with the silicon-based finished products that we are producing and introducing as well.



Electronic Protective Coating

- Protection against Corrosion, mold and electrical failures
- Electrical insulation
- Operation under High voltage
- Ionic and micro-contamination prevention
- Heat resistance between -40° C – 200° C according to the type of product used
- Special coating products

Application Fields

- Circuit Boards
- Military technology
- Space Technology
- Maritime industry
- Lighting
- And such special fields...

Main Products and Services

- Epoxy Products
- Silicone Products
- Urethane Modified Alkyd
- Polyurethane Products
- Acrylic Products
- And such special applications...

Advantages

- Protects Circuit Boards against moisture, salt and various chemicals.
- Prevents the coated component and avoids temperature change effects within the circuit.
- Reduces the impacts of mechanical stress and vibration on the circuit.
- Cures to tough, resilient, abrasion resistant surface.
- Enables automated pattern coating application.
- Applicable by spray, brush, flow and dipping method.
- Availability of acrylic, silicon, urethane, epoxy based products.



“

WACKER CREATING TOMORROW'S SOLUTIONS

PARTNER-COMPOUNDER OF WACKER CHEMIE AG

September 16, 2011

SOLPRO
Danışmanlık Kimya
Sanayi Tic. Ltd. Şti.

signed as
Partnership Agreement

with
Wacker Chemie AG

to produce and sell high-quality compounds of high temperature vulcanizing silicones and is entitled to label them "Based on ELASTOSIL™".

ELASTOSIL™
is a registered trademark of Wacker Chemie AG

Andreas
Dr. Bernd Pachter
Vice President
Engineering Silicones

Axel Schmitt
Axel Schmitt
Director Rubber Solutions
Engineering Silicones

Valid until December 31, 2014

”

Our Company SolPro, which is one of the biggest manufacturers of its field in Europe, has been giving consultancy and engineering services regarding production process and raw materials in various industries, and has been manufacturing tailor made products according to the specific needs of different industries for more than 15 years.

SolPro is the agent, distributor and the Partner Compounder of Wacker Chemie AG of Germany; besides it is the regional distributor for Elantas and Kömmerling / Polycil / Cilbond products.

For various industrial sectors, our company is able to support you with its wide product range and technical capacity in order to help you to choose the right materials for your production process and to develop value-added products, and will be pleased to serve you with the silicon-based finished products that we are producing and introducing as well.



Electronic Protective Coating

- Protection against Corrosion, mold and electrical failures
- Electrical insulation
- Operation under High voltage
- Ionic and micro-contamination prevention
- Heat resistance between -40°C – 200°C according to the type of product used
- Special coating products

Application Fields

- Circuit Boards
- Military technology
- Space Technology
- Maritime industry
- Lighting
- And such special fields...

Main Products and Services

- Epoxy Products
- Silicone Products
- Urethane Modified Alkyd
- Polyurethane Products
- Acrylic Products
- And such special applications...

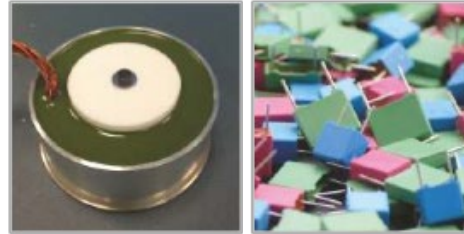

Advantages

- Protects Circuit Boards against moisture, salt and various chemicals.
- Prevents the coated component and avoids temperature change effects within the circuit.
- Reduces the impacts of mechanical stress and vibration on the circuit.
- Cures to tough, resilient, abrasion resistant surface.
- Enables automated pattern coating application.
- Applicable by spray, brush, flow and dipping method.
- Availability of acrylic, silicon, urethane, epoxy based products.



Approvals

Please see the documentation for the approvals required for the sector and the area of use and request detailed information about our products.

- REACH
- RoHS
- CE
- UL 94- V0/V1
- And different approvals upon request...

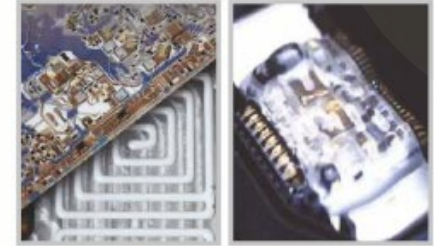

Laboratory Infrastructure

In our laboratory, we have the capability to test;

- Electrical (insulation resistance, conductivity, high voltage, etc.) properties,
- Mechanical (tensile-rupture, hardness, permanent deformation, etc.) properties,
- Physical (rheometer, viscosity, geometric measurements) Before and After extensive Analysis,
- Different aging,
- Flame resistance,
- And many other tests, thanks to our experienced staff and extensive portfolio of test equipment.



Technical Support

Product Development:
If you have a product that you want to produce, but you have difficulty in Choosing raw materials,

Technical Specs:
If you have a critical technical specification or specification,

Process:
If you have problems with molding, injection, extrusion, autoclave, calendaring or whatever process you want, and want to increase your productivity,

Standards and Certification:
If the sectors you are addressing and your customers require compliance and certification to certain standards,

Continuity in Quality:
If you have mechanical, physical, chemical or only constant color expectations, if you have difficulty in obtaining the desired quality and specifications,

Product and Market Development:
New openings for or company if you are looking for new products, new processes and new markets.



Flyer Construction

Official Partner of Wacker Chemie AG

sol pro
Solution Provider

Your Solution Provider for
High Performance Elastomers!

inoser
www.solpro-tr.com

Our company SolPro, which is one of the biggest manufacturers of its field in Europe, has been giving consultancy and engineering services regarding production process and raw materials in various industries, and has been manufacturing tailor made products according to the specific needs of different industries for more than 15 years.

SolPro is the agent, distributor and the Partner Compounder of Wacker Chemie AG of Germany; besides it is the regional distributor for Elastar and Klemmering / Polysil / Oilbond products.

For various industrial sectors, our company is able to support you with its wide product range and technical capacity in order to help you to choose the right materials for your production process and to develop value-added products; we will also be pleased to serve you with the silicon-based finished products that we are producing and introducing in this structure.



Silicone Gasket And Profiles General Features

- Specifications acc. to all kind of shapes and conditions,
- Electrical, thermal conductivity and insulation,
- Flame and Fire resistance,
- Very good permanent deformation,
- Unique UV resistance,
- Resistance to harsh environmental conditions,
- Stable properties in a very wide temperature range,
- Resistant to -60 °C to +110 °C in static and dynamic environments,
- 180 °C, 250 °C, even above 300 °C continuous service temperatures, etc.

Silicone Profile And Gasket Types

- PVC Window and Door System Gaskets
- Aluminium Door And Window System Seals
- Steel Door Seals
- Wooden Door And Window System Seals
- Flapper Seals
- Exterior Wall Coatings
- Dilatation Seals
- Automatic Door Seals
- Exterior Cladding Profiles
- Glass Profiles etc.

Product Information

- Standard Products
- Economic Products
- High Tear Resistant Products
- Special Oil And Chemical Resistant Products



“

WACKER CREATING TOMORROW'S SOLUTIONS

PARTNER COMPOUNDER OF WACKER CHEMIE AG

September 16, 2011

SOLPRO Danışmanlık Kimya Sanayi Tic. Ltd. Şti.

signed as
Partnership Agreement

with
Wacker Chemie AG

to produce and sell high-quality compounds of high temperature vulcanizing silicones and is entitled to label them "Based on ELASTOSIL™".

ELASTOSIL™
A WACKER CHEMIE AG PRODUCT

Handwritten signature
Dr. Bernd Pachter
Vice President
Engineering Silicones

Handwritten signature
Axel Schmitt
Director Rubber Solutions
Engineering Silicones

Valid until December 31, 2014

”

Our company SolPro, which is one of the biggest manufacturers of its field in Europe, has been giving consultancy and engineering services regarding production process and raw materials in various industries, and has been manufacturing tailor made products according to the specific needs of different industries for more than 15 years.

SolPro is the agent, distributor and the Partner Compounder of Wacker Chemie AG of Germany; besides it is the regional distributor for Elantas and Kömmerling / Polycil / Cilbond products.

For various industrial sectors, our company is able to support you with its wide product range and technical capacity in order to help you to choose the right materials for your production process and to develop value-added products; we will also be pleased to serve you with the silicon-based finished products that we are producing and introducing in this brochure.

Silicone Gasket And Profiles General Features

- Specifications acc. to all kind of shapes and conditions,
- Electrical, thermal conductivity and insulation,
- Flame and Fire resistance,
- Very good permanent deformation,
- Unique UV resistance,
- Resistance to harsh environmental conditions,
- Stable properties in a very wide temperature range,
- Resistant to -60 ° C or -110 ° C in static and dynamic environments,
- 180 ° C, 250 ° C, even above 300 ° C continuous service temperatures, etc.

Silicone Profile And Gasket Types

- PVC Window and Door System Gaskets
- Aluminum Door And Window System Seals
- Steel Door Seals
- Wooden Door And Window System Seals
- Flapper Seals
- Exterior Wall Coatings
- Dilatation Seals
- Automatic Door Seals
- Exterior Cladding Profiles
- Glass Profiles etc.

Product Information

- Standard Products
- Economic Products
- High Tear Resistant Products
- Special Oil And Chemical Resistant Products

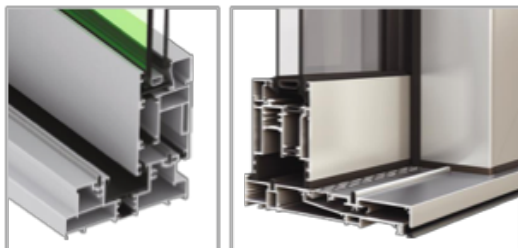

Approvals

Please ask for detailed information on the documents and approvals required by the industry sector and the area of application

- Food Compliance
- Medical
- Drinking Water
- Automotive
- Other Industrial, International and Local Approvals

Laboratory Infrastructure

In our laboratory, we have the capability to test;

- Electrical (Insulation Resistance, Conductivity, High Voltage, etc.)
- Mechanical (Tensile-Rupture, Hardness, Permanent Deformation, etc.)
- Physical (Rheometri, Viscosity, Geometric Measurements)-Before and After Extensive Analysis,
- Different Aging,
- Flame Resistance,
- And many others, thanks to our experienced staff and extensive Portfolio of test equipment.

Technical Support

Product Development:

If you have a product that you want to produce, but you face difficulty in choosing the right raw materials,

Technical Specifications:

If you have a critical technical specification or stipulation you shall meet,

Process:

Forming, injection, extrusion, autoclave, calendaring...

Whatever process you may have and any problem you face, and if you want to increase your efficiency

Standards and Certification:

If the sectors you are addressing and your customers require compliance to certain standards and certification

Quality Assurance;

Mechanical, physical, chemical or only if you have fixed color expectations, If you have difficulty in getting the products you want with the quality and features you need,

Product and Market Development:

Looking for new products, new processes and new markets for your company...



Flyer LED

Official Partner of Wacker Chemie AG

sol pro
Solution Provider

High Performance Elastomers
Your Solution Partner!

inoser
www.solpro-tr.com

Our Company SolPro, which is one of the biggest manufacturers of its field in Europe, has been giving consultancy and engineering services regarding production process and raw materials in various industries, and has been manufacturing tailor made products according to the specific needs of different industries for more than 15 years.

SolPro is the agent, distributor and the Partner Compounder of Wacker Chemie AG of Germany; besides it is the regional distributor for Elantas and Kömmerling / Polycil / Cibond products.

For various industrial sectors, our company is able to support you with its wide product range and technical capacity in order to help you to choose the right materials for your production process and to develop value-added products, and will be pleased to serve you with the silicon-based finished products that we are producing and introducing as well.



Led Lightinge

- Electrical Insulation
- Wide operation temperature range
- Chemical resistance
- UV Resistance
- Protection against corrosion, moisture, migration and vibration
- -40°C – 200°C High Thermal Conductivity

Application Fields

- Diode top crystal clear applications
- Decorative Applications
- Exterior Lighting / Outdoor Lighting
- Underwater applications
- Military applications (Potting applications requiring low temperature, high temperature resistance)
- Driver external environment protection applications
- Medical applications
- And such special applications....

Main Products and Services

- Transparent Led Silicone
- Transparent Led Polyurethane
- Silicone Potting Product
- Polyurethane Potting Product
- And such special products and services....

Advantages

- Crystal Clarity
- Low Viscosity
- Allows repair
- Provides resistance to thermal shocks.
- Elastic structure allows thermal expansion.
- Full protection against water, dust and moisture at IP-68 level



“



”

Our Company SolPro, which is one of the biggest manufacturers of its field in Europe, has been giving consultancy and engineering services regarding production process and raw materials in various industries, and has been manufacturing tailor made products according to the specific needs of different industries for more than 15 years.

SolPro is the agent, distributor and the Partner Compounder of Wacker Chemie AG of Germany; besides it is the regional distributor for Elantas and Kömmerling / Polycil / Cilbond products.

For various industrial sectors, our company is able to support you with its wide product range and technical capacity in order to help you to choose the right materials for your production process and to develop value-added products, and will be pleased to serve you with the silicon-based finished products that we are producing and introducing as well.



Led Lightinge

- Electrical Insulation
- Wide operation temperature range
- Chemical resistance
- UV Resistance
- Protection against corrosion, moisture, migration and vibration
- -40°C ~ 200°C High Thermal Conductivity

Application Fields

- Diode top crystal clear applications
- Decorative Applications
- Exterior Lighting / Outdoor Lighting
- Underwater applications
- Military applications (Potting applications requiring low temperature, high temperature resistance)
- Driver external environment protection applications
- Medical applications
- And such special applications...

Main Products and Services

- Transparent Led Silicone
- Transparent Led Polyurethane
- Silicone Potting Product
- Polyurethane Potting Product
- And such special products and services...



Advantages

- Crystal Clarity
- Low Viscosity
- Allows repair
- Provides resistance to thermal shocks.
- Elastic structure allows thermal expansion.
- Full protection against water, dust and moisture at IP-68 level



Approvals

Please see the documentation for the approvals required for the sector and the area of use and request detailed information about our products.

- REACH
- RoHS
- CE
- UL 94- V0/V1
- And such approvals...



Laboratory Infrastructure

In our laboratory, we have the capability to test;

- Electrical (insulation resistance, conductivity, high voltage, etc.) properties,
- Mechanical (tensile-rupture, hardness, permanent deformation, etc.) properties,
- Physical (rheometer, viscosity, geometric measurements) Before and After extensive Analysis,
- Different aging,
- Flame resistance,
- And many other tests, thanks to our experienced staff and extensive portfolio of test equipment.



Technical Support

Product Development:

If you have a product that you want to produce, but you have difficulty in Choosing raw materials,

Technical Specs:

If you have a critical technical specification or specification,

Process:

If you have problems with molding, injection, extrusion, autoclave, calendaring or whatever process you want, and want to increase your productivity,

Standards and Certification:

If the sectors you are addressing and your customers require compliance and certification to certain standards,

Continuity in Quality:

If you have mechanical, physical, chemical or only constant color expectations, if you have difficulty in obtaining the desired quality and specifications,

Product and Market Development:

New openings for or company if you are looking for new products, new processes and new markets.



Flyer Agro Grafting

Official Partner of Wacker Chemie AG

sol pro
Solution Provider

GRAFTING CLIPS

inoser
www.solpro-tr.com

Our Company SolPro, which is one of the biggest manufacturers of its field in Europe, has been giving consultancy and engineering services regarding production process and raw materials in various industries and has been manufacturing tailor made products according to the specific needs of different industries for more than 15 years.

SolPro is the agent, distributor and the Partner Compounder of Wacker Chemie AG of Germany, besides it is the regional distributor for Elantas and Kömmerling / Polycyl / Cilbond products.

For various industrial sectors, our company is able to support you with its wide product range and technical capacity in order to help you to choose the right materials for your production process and to develop value-added products, and will be pleased to serve you with the silicon-based finished products that we are producing and introducing as well.



Silicone Grafting Clips

- Grafting clips made from a special silicone formulation are used when grafting the heads of fruit trees as a binding element between the base and the fruit variety. They also ensure that the connection has the necessary stability.
- Due to the elastic behavior of the Silicone, the tightness of the grip orientates itself to the resistance of the stalk. Squashing of the stalk is therefore avoided.
- Silicone clips are highly flexible, and this enables the growth between the vaccine base and the head cutting.
- The cut grows out of the clip over time, thus, the clip falls off without human action once the vaccination process is complete.
- Products with appropriate thickness can be adjusted according to the plant or fruit to be used.

Advantages

- Size, Hardness and color adjustment according to product.
- Heat Resistant
- Possibility of sterilization (in case of a requirement for no bacterial contamination)
- Product offers tailor made in different cost structures and need.
- The physiologically harmless nature



Fields of Application

- Seed Grafting Clips
- Tomato Grafting
- Watermelon Grafting
- Rose Grafting
- And for the grafting application of all types of vegetable and fruits

Main Products and Services

- Tube Clips
- Pipe Clips
- Silicone Cases
- And Similar Products in different sizes

“

WACKER CREATING TOMORROW'S SOLUTIONS

PARTNER COMPOUNDER OF WACKER CHEMIE AG

September 16, 2011

SOLPRO Danışmanlık Kimya Sanayi Tic. Ltd. Şti.

signed a
Partnership Agreement

with
Wacker Chemie AG

to produce and sell high-quality compounds of high temperature vulcanizing silicones and is entitled to label them "Based on ELASTOSIL™".

ELASTOSIL™
is a registered trademark of Wacker Chemie AG

Handwritten signature
Dr. Bernd Pachatz
Vice President
Engineering Silicones

Handwritten signature
Axel Schmitt
Director Rubber Solutions
Engineering Silicones

WACKER 2011

”

Our Company SolPro, which is one of the biggest manufacturers of its field in Europe, has been giving consultancy and engineering services regarding production process and raw materials in various industries, and has been manufacturing tailor made products according to the specific needs of different industries for more than 15 years.

SolPro is the agent, distributor and the Partner Compounder of Wacker Chemie AG of Germany; besides it is the regional distributor for Elantas and Kömmerling / Polycil / Cilbond products.

For various industrial sectors, our company is able to support you with its wide product range and technical capacity in order to help you to choose the right materials for your production process and to develop value-added products, and will be pleased to serve you with the silicon-based finished products that we are producing and introducing as well.



Silicone Grafting Clips

- Grafting clips made from a special silicone formulation are used when grafting the heads of fruit trees as a binding element between the base and the fruit variety. They also ensure that the connection has the necessary stability.
- Due to the elastic behavior of the Silicone, the tightness of the grip orientates itself to the resistance of the stalk. Squashing of the stalk is therefore avoided.
- Silicone clips are highly flexible, and this enables the growth between the vaccine base and the head cutting.
- The cut grows out of the clip over time, thus, the clip falls off without human action once the vaccination process is complete.
- Products with appropriate thickness can be adjusted according to the plant or fruit to be used.

Fields of Application

- Seed Grafting Clips
- Tomato Grafting
- Watermelon Grafting
- Rose Grafting
- And for the grafting application of all types of vegetable and fruits

Main Products and Services

- Tube Clips
- Pipe Clips
- Silicone Cases
- And Similar Products in different sizes

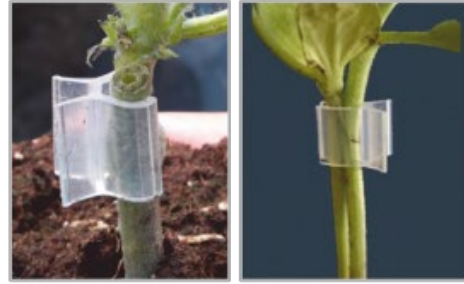

Advantages

- Size, Hardness and color adjustment according to product.
- Heat Resistant
- Possibility of sterilization (in case of a requirement for no bacterial contamination)
- Product offers tailor made in different cost structures and need.
- The physiologically harmless nature

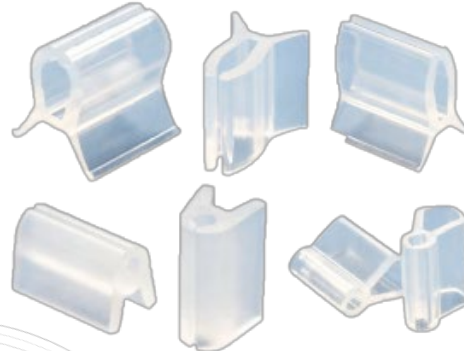

Approvals

Please see the documentation for the approvals for the sector and the area of use and request detailed information about our products.

- REACH Compliance
- RoHS Compliance
- CE Declaration
- FDA Declaration
- BFR Declaration
- And different approvals upon request



Laboratory Infrastructure

In our laboratory; we have the capability to test;

- Electrical (insulation resistance, conductivity, high voltage, etc.) properties,
- Mechanical (tensile-rupture, hardness, permanent deformation, etc.) properties,
- Physical (rheometer, viscosity, geometric measurements) Before and After extensive Analysis,
- Different aging,
- Flame resistance,
- And many other tests, thanks to our experienced staff and extensive portfolio of test equipment.



Technical Support

Product Development:
If you have a product that you want to produce, but you have difficulty in Choosing raw materials,

Technical Specs:
If you have a critical technical specification or specification,

Process:
If you have problems with molding, injection, extrusion, autoclave, calendaring or whatever process you want, and want to increase your productivity,

Standards and Certification:
If the sectors you are addressing and your customers require compliance and certification to certain standards,

Continuity in Quality:
If you have mechanical, physical, chemical or only constant color expectations, if you have difficulty in obtaining the desired quality and specifications,

Product and Market Development:
New openings for or company if you are looking for new products, new processes and new markets.



Flyer Textile

Official Partner of Wacker Chemie AG

solpro
Solution Provider

Your Solution Provider in
High Performance Elastomers!

inoSer
www.solpro-tr.com

Our Company SolPro, which is one of the biggest manufacturers of its field in Europe, has been giving consultancy and engineering services regarding production processes and raw materials in various industries, and has been manufacturing tailor made products according to the specific needs of different industries for more than 15 years.

SolPro is the agent, distributor and the Partner Compounder of Wacker Chemie AG of Germany; besides it is the regional distributor for Elastas and Kimmerring / Polych / Cibond products.

For various industrial sectors, our company is able to support you with its wide product range and technical capacity in order to help you to choose the right materials for your production process and to develop value-added products, and will be pleased to serve you with the silicon-based finished products that we are producing and introducing as well.



Silicone Textile Products

- Used in lingerie and socks to provide adherence to the skin,
- It is used especially for children's socks to prevent slipping,
- Excellent adhesion performance on all sorts of fabrics and fibers.
- Thanks to its flexible and soft structure, it does not cause any discomfort in the places where it touches the skin,
- It is highly transparent and easily colorable,
- Heat resistance,
- Flame retardant and heat-proof versions are available for special applications.

Fields of Application

- Embossing
- Impregnation
- Silk Printing
- Drop Printing
- Injection
- And each different fields of application

Main Products and Services

- RTV1 - Single component Silicone products with room temperature curing
- RTV2 - Two-component Silicone products with room temperature curing
- LSR - Two-component Liquid Silicone Products with High Temperature curing
- And similar products for different applications



Advantages

- Adjustable viscosity with respect to process
- Shore adjustment according to product
- Product grades with different coil structures
- Hydrophobic Properties
- Adjustable vulcanization speed with respect to process



“

WACKER CREATING TOMORROW'S SOLUTIONS
PARTNER COMPOUNDER OF WACKER CHEMIE AG

September 16, 2011

SOLPRO
Danışmanlık Kimya
Sanayi Tic. Ltd. Şti.

signed as
Partnership Agreement

with
Wacker Chemie AG

to produce and sell high-quality compounds of high temperature vulcanizing silicones and is entitled to label them "Based on ELASTOSIL™".

ELASTOSIL™
A WACKER CHEMIE AG PRODUCT

Bernd Pachter
Dr. Bernd Pachter
Vice President
Engineering Silicones

Axel Schmitt
Axel Schmitt
Director Rubber Solutions
Engineering Silicones

Valid until December 31, 2014

”

Our Company SolPro, which is one of the biggest manufacturers of its field in Europe, has been giving consultancy and engineering services regarding production process and raw materials in various industries, and has been manufacturing tailor made products according to the specific needs of different industries for more than 15 years.

SolPro is the agent, distributor and the Partner Compounder of Wacker Chemie AG of Germany; besides it is the regional distributor for Elantas and Kömmerling / Polycil / Cilbond products.

For various industrial sectors, our company is able to support you with its wide product range and technical capacity in order to help you to choose the right materials for your production process and to develop value-added products, and will be pleased to serve you with the silicon-based finished products that we are producing and introducing as well.



Silicone Textile Products

- Used in lingerie and socks to provide adherence to the skin,
- It is used especially for children's socks to prevent slipping,
- Excellent adhesion performance on all sorts of fabrics and lace,
- Thanks to its flexible and soft structure, it does not cause any discomfort in the places where it touches the skin,
- It is highly transparent and easily colorable,
- Heat Resistance,
- Flame retardant and heat-proof versions are available for special applications.

Fields of Application

- Embossing
- Impregnation
- Silk Printing
- Drop Printing
- Injection
- And such different fields of application

Main Products and Services

- RTV1 – Single component Silicone products with room temperature curing
- RTV2 - Two-component Silicone products with room temperature curing
- LSR - Two-component Liquid Silicone Products with High Temperature curing
- And similar products for different applications



Advantages

- Adjustable viscosity with respect to process
- Shore adjustment according to product
- Product grades with different cost structures
- Hydrophobic Properties
- Adjustable vulcanization speed with respect to process



Compliance and Approvals

Please see the documentation for the approvals required for the sector and the area of use and request detailed information about our products.

- REACH Compliance
- RoHS Compliance
- CE Declaration
- Deko Tex 100 Compliance
- And different approvals upon request



Laboratory Infrastructure

In our laboratory, we have the capability to test;

- Electrical (insulation resistance, conductivity, high voltage, etc.) properties,
- Mechanical (tensile-rupture, hardness, permanent deformation, etc.) properties,
- Physical (rheometer, viscosity, geometric measurements) Before and After extensive Analysis,
- Different aging,
- Flame resistance,
- And many other tests, thanks to our experienced staff and extensive portfolio of test equipment.



Technical Support

Product Development:

If you have a product that you want to produce, but you have difficulty in Choosing raw materials,

Technical Specs:

If you have a critical technical specification or specification,

Process:

If you have problems with molding, injection, extrusion, autoclave, calendaring or whatever process you want, and want to increase your productivity,

Standards and Certification:

If the sectors you are addressing and your customers require compliance and certification to certain standards,

Continuity in Quality:

If you have mechanical, physical, chemical or only constant color expectations, if you have difficulty in obtaining the desired quality and specifications,

Product and Market Development:

New openings for or company if you are looking for new products, new processes and new markets.



Flyer Agro Farming

Official Partner of Wacker Chemie AG

sol pro Solution Provider **inoser** Your Solution Provider in High Performance Elastomers! www.solpro-tr.com

Our Company SolPro, which is one of the biggest manufacturers of its field in Europe, has been giving consultancy and engineering services regarding production process and raw materials in various industries, and has been manufacturing tailor made products according to the specific needs of different industries for more than 15 years.

SolPro is the agent, distributor and the Partner Compounder of Wacker Chemie AG of Germany, besides it is the regional distributor for Elastar and Kommerling Polysil / Dicoind products.

For various industrial sectors, our company is able to support you with its wide product range and technical capacity in order to help you to choose the right materials for your production process and to develop value-added products, and will be pleased to serve you with the silicon-based finished products that we are producing and introducing as well.



Agriculture and Farming Equipment

- Silicone Gaskets used in Pitchers bring sealing feature;
- These are resistant to time and heat; does not deform;
- Have resistance to chemicals;
- These flexible and soft products do not cause any problems when in contact with sensitive skin;
- Due to the elastic behavior of the silicone grafting clips, it adapts itself to the tightness and resistance of the stalk; deformation and squashing of the stalk is therefore avoided;
- Suitable for food contact; do not contain harmful chemicals

Fields of Application

- Seed Grafting Clips
- Garden Hoses
- Milking Equipment Parts
- Calf Bearings
- Gag Cover Seats
- Breast Feeding Nozzles
- And similar special industrial fields

Main Products and Services

- Milking Hoses
- Seals and Bearings
- Milking Nipple Nozzles
- Grafting Clips
- And similar products for different special applications

Advantages

- Assembled or unassembled parts and products of different lengths
- Hardness and color adjustment according to product
- Product offers acc. to different cost structures
- The physiologically harmless nature



“



”

Our Company SolPro, which is one of the biggest manufacturers of its field in Europe, has been giving consultancy and engineering services regarding production process and raw materials in various industries, and has been manufacturing tailor made products according to the specific needs of different industries for more than 15 years.

SolPro is the agent, distributor and the Partner Compounder of Wacker Chemie AG of Germany; besides it is the regional distributor for Elantas and Kömmerling / Polycil / Cibond products.

For various industrial sectors, our company is able to support you with its wide product range and technical capacity in order to help you to choose the right materials for your production process and to develop value-added products, and will be pleased to serve you with the silicon-based finished products that we are producing and introducing as well.



Agriculture and Farming Equipment

- Silicone Gaskets used in Pitchers bring sealing feature;
- These are resistant to time and heat, does not deform;
- Have resistance to chemicals;
- These flexible and soft products do not cause any problems when in contact with sensitive skin;
- Due to the elastic behavior of the silicone grafting clips, it adapts itself to the tightness and resistance of the stalk; deformation and squashing of the stalk is therefore avoided;
- Suitable for food contact; do not contain harmful chemicals

Fields of Application

- Seed Grafting Clips
- Garden Hoses
- Milking Equipment Parts
- Calf Bearings
- Gag Cover Seals
- Breast Feeding Nozzles
- And similar special industrial fields

Main Products and Services

- Milking Hoses
- Seals and Bearings
- Milking Nipple Nozzles
- Grafting Clips
- And similar products for different special applications



Advantages

- Assembled or unassembled parts and products of different lengths
- Hardness and color adjustment according to product
- Product offers acc. to different cost structures
- The physiologically harmless nature



Compliance and Approvals

Please see the documentation for the approvals for the sector and the area of use and request detailed information about our products.

- REACH Compliance
- RoHS Compliance
- CE Declaration
- FDA Declaration
- BIR Declaration
- And different approvals upon request



Laboratory Infrastructure

In our laboratory, we have the capability to test;

- Electrical (insulation resistance, conductivity, high voltage, etc.) properties,
- Mechanical (tensile-rupture, hardness, permanent deformation, etc.) properties,
- Physical (rheometer, viscosity, geometric measurements) Before and After extensive Analysis,
- Different aging,
- Flame resistance,
- And many other tests, thanks to our experienced staff and extensive portfolio of test equipment.



Technical Support

Product Development:

If you have a product that you want to produce, but you have difficulty in Choosing raw materials,

Technical Specs:

If you have a critical technical specification or specification,

Process:

If you have problems with molding, injection, extrusion, autoclave, calendaring or whatever process you want, and want to increase your productivity,

Standards and Certification:

If the sectors you are addressing and your customers require compliance and certification to certain standards,

Continuity in Quality:

If you have mechanical, physical, chemical or only constant color expectations, if you have difficulty in obtaining the desired quality and specifications,

Product and Market Development:

New openings for or company if you are looking for new products, new processes and new markets.



Flyer Industrial Kitchen

Official Partner of Wacker Chemie AG

solpro Solution Provider **ino ser** Your Solution Provider in High Performance Elastomers! www.solpro-tr.com

Our Company SolPro, which is one of the biggest manufacturers of its field in Europe, has been giving consultancy and engineering services regarding production process and raw materials in various industries, and has been manufacturing tailor made products according to the specific needs of different industries for more than 15 years.

SolPro is the agent, distributor and the Partner Compounder of Wacker Chemie AG of Germany, besides it is the regional distributor for Elantas and Körnerling / Polycol / Cibond products.

For various industrial sectors, our company is able to support you with its wide product range and technical capacity in order to help you to choose the right materials for your production process and to develop value-added products, and will be pleased to serve you with the silicon-based finished products that we are producing and introducing as well.



Silicone Industrial Kitchen Products

- Gaskets used in ovens and freezers provide temperature resistance between -60°C and 300°C;
- Resistant to deformation due to time and heat;
- It has sealing property to avoid heat, odor and vapor release;
- Resistant to chemicals;
- Suitable for food contact.

Fields of Application

- Industrial Ovens
- Banquet Carts
- Ovens Freezers and Cold Storage Rooms
- Sealing Gastroscopic Bathbub Covers
- Food Vacuum Machines
- Transport carts
- Shower Faucet Units
- And Similar Areas Requiring High Heat Resistance

Advantages

- Gaskets that can be used with or without clips
- Assembled or unassembled parts and profiles in different lengths
- Hardness and color adjustment according to product
- Cost-effective product preparation
- Product preparation for open and closed frames

Compliance and Approvals

- Oven door gaskets
- Various heat-resistant sealing gaskets
- Profiles
- Handles and Covers
- Silicone wedges
- RTV Structural / Industrial Adhesives
- And similar products for different applications



“

WACKER CREATING TOMORROW'S SOLUTIONS
PARTNER COMPOUNDER OF WACKER CHEMIE AG

September 16, 2011

SOLPRO Danışmanlık Kimya Sanayi Tic. Ltd. Şti.

signed a
Partnership Agreement

with
Wacker Chemie AG

to produce and sell high-quality compounds of high temperature vulcanizing silicones and is entitled to label them "Based on ELASTOSIL™".

ELASTOSIL
is a registered trademark of Wacker Chemie AG

Handwritten signature
Dr. Bernd Pachatz
Vice President
Engineering Silicones

Handwritten signature
Axel Schmitt
Director Rubber Solutions
Engineering Silicones

Valid until December 31, 2014

”

Our Company SolPro, which is one of the biggest manufacturers of its field in Europe, has been giving consultancy and engineering services regarding production process and raw materials in various industries, and has been manufacturing tailor made products according to the specific needs of different industries for more than 15 years.

SolPro is the agent, distributor and the Partner Compounder of Wacker Chemie AG of Germany; besides it is the regional distributor for Elantas and Kömmerling / Polycil / Cilbond products.

For various industrial sectors, our company is able to support you with its wide product range and technical capacity in order to help you to choose the right materials for your production process and to develop value-added products, and will be pleased to serve you with the silicon-based finished products that we are producing and introducing as well.



Silicone Industrial Kitchen Products

- Gaskets used in ovens and freezers provide temperature resistance between -60°C and 300°C;
- Resistant to deformation due to time and heat;
- It has sealing property to avoid heat, odor and vapor release;
- Resistant to chemicals;
- Suitable for food contact.

Fields of Application

- Industrial Ovens
- Banquet Cars
- Deep Freezers and Cold Storage Rooms
- Sealing Gastronomic Bathtub Covers
- Food Vacuum Machines
- Transport carts
- Shower Faucet Units
- And Similar Areas Requiring High Heat Resistance

Compliance and Approvals

- Oven door gaskets
- Various heat-resistant sealing gaskets
- Profiles
- Handles and Covers
- Silicone wedges
- RTV Structural / Industrial Adhesives
- And similar products for different applications



Advantages

- Gaskets that can be used with or without clips
- Assembled or unassembled parts and profiles in different lengths
- Hardness and color adjustment according to product
- Cos-effective product preparation
- Product preparation for open and closed frames



Approvals

Please see the documentation for the approvals required for the sector and the area of use and request detailed information about our products.

- REACH Compliance
- RoHS Compliance
- CE Declaration
- FDA Declaration
- BFR Declaration
- And different approvals upon request

Laboratory Infrastructure

In our laboratory; we have the capability to test;

- Electrical (insulation resistance, conductivity, high voltage, etc.) properties,
- Mechanical (tensile-rupture, hardness, permanent deformation, etc.) properties,
- Physical (rheometer, viscosity, geometric measurements) Before and After extensive Analysis,
- Different aging,
- Flame resistance,
- And many other tests, thanks to our experienced staff and extensive portfolio of test equipment.

Technical Support

Product Development:

If you have a product that you want to produce, but you have difficulty in Choosing raw materials,

Technical Specs:

If you have a critical technical specification or specification,

Process:

If you have problems with molding, injection, extrusion, autoclave, calendaring or whatever process you want, and want to increase your productivity,

Standards and Certification:

If the sectors you are addressing and your customers require compliance and certification to certain standards,

Continuity in Quality:

If you have mechanical, physical, chemical or only constant color expectations, if you have difficulty in obtaining the desired quality and specifications,

Product and Market Development:

New openings for or company if you are looking for new products, new processes and new markets.



Flyer Fire Safety

Official Partner of Wacker Chemie AG

solpro
Solution Provider

Your Solution Provider in
High Performance Elastomers!

inoser
www.solpro-tz.com

Our company Solpro, which is one of the biggest manufacturers of its field in Europe, has been giving consultancy and engineering services regarding production process and raw materials in various industries, and has been manufacturing tailor made products according to the specific needs of different industries for more than 15 years.

Solpro is the agent, distributor and the Partner Compounder of Wacker Chemie AG of Germany besides it is the regional distributor for Elastas and Kimmertling / Polysil / Cilbond products.

For various industrial sectors, our company is able to support you with its wide product range and technical capacity in order to help you to choose the right materials for your production process and to develop value-added products; we will also be pleased to serve you with the silicon-based finished products that we are producing and introducing.



Fire Resistant Cables

- should be flame retardant and the cable should get extinguished by itself when the fire is over;
- Should not emit gases that are harmful to human health while burning and must be free of halogen;
- that provide signal and energy to Control and Communication systems that need to operate for a certain period of time during the fire must be resistant to fire for at least 60 minutes.
- should emit low smoke density under fire. This feature is critical in terms of helping the evacuation and the fire extinguishing efforts.

Fields of Application

- Fire Alarm Systems
- Fire Extinguishing Systems,
- Emergency Lighting Systems,
- Elevators,
- Emergency Alarm Systems
- And such special applications...

Main Products and services

- Different types of insulation materials that turn in to ceramic form under fire (flexible, semi-flexible and hard ceramic types)
- Economical Type Cable Insulation and Sheathing Materials
- FE 180 Resistant Insulation Materials
- pH 180 Resistant Insulation Materials
- BS4397 CWZ Type Insulation Materials
- Insulation Materials Resistant to impact and water spout
- Insulation Materials for Data, Signal and Energy Cables
- Insulation Materials for special areas such as Marine, Mining, etc.
- Insulation material for systems such as CV, Hot Air Tunnel, Salt Bath
- Products suitable for vertical and horizontal extrusion
- Special materials resistant to high tensile breaking end with high raw tensile strength

Flame Resistance Test Standards

- Flame Retardancy (IEC 60332-1-2 / VDE 0482-332-1-2 / EN 60332-1-2 / BS EN 60332-1-2)
- Impact under insulation circuit integrity (PH) - (EN 50200, VDE 0482-200)
- Flame spread (IEC 60332-3 / VDE 0482-332-3 / EN 60332-3 / BS EN 60332-3)
- Smoke Density (IEC 61034-2 / VDE 0482-1034-2 / EN 61034-2 / BS EN 61034-2)
- Halogen Acid Gas Determination (IEC 60754-1 / EN 50267-2-1 / VDE 0482-267-2-1 / BS EN 50267-2-1)
- Insulation Circuit Integrity (FE 180) - (IEC 60331-23, VDE 0472-814)



“

WACKER CREATING TOMORROW'S SOLUTIONS

PARTNER COMPOUNDER OF WACKER CHEMIE AG

September 16, 2011

SOLPRO Danışmanlık Kimya Sanayi Tic. Ltd. Şti.

signed a
Partnership Agreement

with
Wacker Chemie AG

to produce and sell high-quality compounds of high temperature vulcanizing silicones and is entitled to label them "Based on ELASTOSIL™".

ELASTOSIL™
A registered trademark of Wacker Chemie AG

Handwritten signature
Dr. Bernd Pachter
Vice President
Engineering Silicones

Handwritten signature
Axel Schmitt
Director Rubber Solutions
Engineering Silicones

Valid until December 31, 2014

”

Our company SolPro, which is one of the biggest manufacturers of its field in Europe, has been giving consultancy and engineering services regarding production process and raw materials in various industries, and has been manufacturing tailor made products according to the specific needs of different industries for more than 15 years.

SolPro is the agent, distributor and the Partner Compounder of Wacker Chemie AG of Germany; besides it is the regional distributor for Elantas and Kömmerling / Polycil / Cilbond products.

For various industrial sectors, our company is able to support you with its wide product range and technical capacity in order to help you to choose the right materials for your production process and to develop value-added products; we will also be pleased to serve you with the silicon-based finished products that we are producing and introducing.

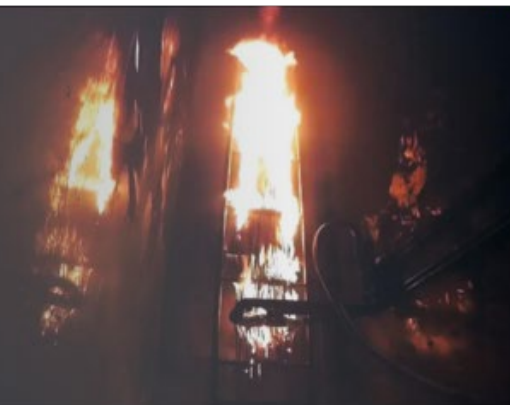

Fire Resistant Cables

- should be flame retardant and the cable should get extinguished by itself when the fire is over;
- Should not emit gases that are harmful to human health while burning and must be free of halogen;
- that provide signal and energy to Control and Communication systems that need to operate for a certain period of time during the fire must be resistant to fire for at least 60 minutes.
- should emit low smoke density under fire. This feature is critical in terms of helping the evacuation and the fire extinguishing efforts.

Fields of Application

- Fire Alarm Systems
- Fire Extinguishing Systems,
- Emergency Lighting Systems,
- Elevators,
- Emergency Alarm Systems
- And such special applications...

Main Products and services

- Different type of insulation materials that turn in to ceramic form under fire (flexible, semi-flexible and hard ceramic types)
- Economical Type Cable Insulation and Sheathing Materials
- FE180 Resistant Insulation Materials
- ph180 Resistant Insulation Materials
- BS6387 CWZ Type Insulation Materials
- Insulation Materials Resistant to impact and water spout
- Insulation Materials for Data, Signal and Energy Cables
- Insulation Materials for special areas such as Marine, Mining, etc.
- Insulation material for systems such as CV, Hot Air Tunnel, Salt Bath
- Products suitable for vertical and horizontal extrusion
- Special materials resistant to high tensile breaking and with high raw tensile strength



Flame Resistance Test Standards

- Flame Retardancy (IEC 60332-1-2 / VDE 0482-332-1-2 / EN 60332-1-2 / BS EN 60332-1-2)
- Impact under insulation circuit integrity (PH) – (EN 50200, VDE 0482-200)
- Flame spread (IEC 60332-3 / VDE 0482-332-3 / EN 60332-3 / BS EN 60332-3)
- Smoke Density (IEC 61034-2 / VDE 0482-1034-2 / EN 61034-2 / BS EN 61034-2)
- Halogen Acid Gas Determination (IEC 60754-1 / EN 50267-2-1 / VDE 0482-267-2-1 / BS EN 50267-2-1)
- Insulation Circuit Integrity (FE 180) – (IEC 60331-23, VDE 0472-814)



Approvals

Please ask for detailed information on the documents and approvals required by the industry sector and the area of application

- VDE
- HAR
- BS
- LPCB
- E12, E18, HIC conformities
- And such approvals required by different standards...



Laboratory Infrastructure

In our laboratory, we have the capability to test;

- Electrical (Insulation Resistance, Conductivity, High Voltage, etc.) properties,
- Mechanical (Tensile-Rupture, Hardness, Permanent Deformation, etc.) properties,
- Do Physical (rheometer, viscosity, geometric measurements) Before and After extensive Analysis,
- Different Aging
- Flame Resistance
- And many other tests, thanks to our experienced staff and extensive Portfolio of testing equipment.



Technical Support

Product Development:

If you have a product that you want to produce, but you face difficulty in choosing the right raw materials,

Technical Specifications:

If you have a critical technical specification or stipulation you shall meet,

Proses:

Forming, injection, extrusion, autoclave, calendaring..

Whatever process you may have and any problem you face, and if you want to increase your efficiency

Standards and Certification:

If the sectors you are addressing and your customers require compliance to certain standards and certification

Quality continuity;

Mechanical, physical, chemical or only if you have fixed color expectations, if you have difficulty in getting the products you want with quality and features you need,

Product and Market Development:

Looking for new products, new processes and new markets for your company...



Flyer Profiles and Hoses

Official Partner of Wacker Chemie AG

solpro
Çözüm Ortağınız

**Yüksek Performans Elastomerlerinde
Çözüm Ortağınız !**

Solpro, silikon kauçuk ham madde ve karışımlar üreten ve tedarik eden bir firmadır. Wacker Grubun Türkiye'deki Partneri ve Wacker tescilli markası Elastosil adı ile yüksek kaliteli compound üreticisidir.
15 yılı aşkın süredir VMQ, FKM, HIER, EPDM, CR, NBR ve farklı endüstrilerde, üretim süreçlerinde kullanılan çeşitli katkı maddeleri ve malzeme tedariki ile alanında dengelenmiş ve mühendislik hizmetleri vermeye olan şirketimiz müşteri taleplerini doğrultusunda özel üretimler de yapmaktadır.
Bugün firmamız, VMQ konusunda Avrupa'nın en büyük üreticisidir, bu sebeple silikon kauçuk üretimi alanında sadece ulusal değil uluslararası şirketler ile çalışmakta ve ürünlerinin bir kısmını ihraç etmektedir.
Çeşitli sanayi sektörleri için, üretim sürecinizdeki malzemeleri seçerken size faydalı olabilecek geniş bir ürün yelpazesine sahibiz.
Üniteminizde kullanılmakta olduğunuz ve/veya geliştirmek istediğiniz ürün ve prosesleriniz için tarafımızla bağlanıp kurmanız halinde sizlere hizmet vermektен memnuniyet duyuyoruz.
Detaylı ve ek bilgiyi şirketimizin www.solpro-tr.com adresinden temin edebilirsiniz.

Silikon Conta ve Profillerin Genel Özellikleri

- Her türlü şekli ve boyutlu,
- Elektriksel, ısıl iletkenlik ve yalıtıkanlık,
- Alev ve yangın dayanımı,
- Çok iyi kalıcı deformasyon,
- Eşsiz UV dayanımı,
- Eşsiz çarpma şartlarına karşı dayanım,
- Çok geniş sıcaklık aralığında stabil özellikler,
- Statik ve dinamik ortamlarda -60°C hatta -110°C dayanım,
- 180°C, 250°C hatta 300°C sürekli servis sıcaklıktan.



Silikon Profil ve Conta Çeşitleri

- PVC Pencere ve Kapı Sistemli Contaları
- Alüminyum Kapı ve Pencere Sistem Contaları
- Çelik Kapı Contaları
- Ahşap Kapı ve Pencere Sistem Contaları
- Sineklik Contaları
- Diğ. Çeşitli Geyirme Contaları
- Dilatasyon Contaları
- Otomatik Kapı Contaları
- Diğ. Çeşitli Geyirme Profilleri
- Cam Profilleri



Tel: +90 216 378 79 80 • www.solpro-tr.com • info@solpro-tr.com

“



”

Solpro, silikon kauçuk ham madde ve karışımlar üreten ve tedarik eden bir firmadır; Wacker Grubun Türkiye'deki Partneri ve Wacker tescilli markası Elastosil adı ile yüksek kaliteli compound üreticisidir.

15 yılı aşkın süredir VMQ, FKM, HNBR, EPDM, CR, NBR ve farklı endüstrilerde, üretim süreçlerinde kullanılan çeşitli katkı maddeleri ve malzeme tedariki ile alanında danışmanlık ve mühendislik hizmetleri vermekte olan şirketimiz müşteri talepleri doğrultusunda özel üretimler de yapmaktadır.

Bugün firmamız, VMQ karışım konusunda Avrupa'nın en büyük üreticisidir, bu sebeple silikon kauçuk üretimi alanında sadece ulusal değil uluslararası şirketler ile çalışmakta ve ürünlerinin bir kısmını ihraç etmektedir.

Çeşitli sanayi sektörleri için, üretim sürecinizdeki malzemeleri seçerken size faydalı olabilecek geniş bir ürün yelpazesine sahibiz.

Üretiminizde kullanmakta olduğunuz ve/veya geliştirmek istediğiniz ürün ve prosesleriniz için tarafımızla bağlantı kurmanız halinde sizlere hizmet vermekten memnuniyet duyacağız.

Detaylı ve ek bilgiyi şirketimizin www.solpro-tr.com adresinden temin edebilirsiniz.

Silikon Conta ve Profillerin Genel Özellikleri

- Her türlü şekil ve özellikte,
- Elektriksel, ısı iletkenlik ve yalıtıncılık,
- Alev ve yangın dayanımı,
- Çok iyi kalıcı deformasyon,
- Eşsiz UV dayanımı,
- Eşsiz çevre şartlarına karşı dayanım,
- Çok geniş sıcaklık aralığında stabil özellikler,
- Statik ve dinamik ortamlarda -60°C hatta -110°C dayanım,
- 180°C, 250°C hatta 300°C sürekli servis sıcaklıklar.

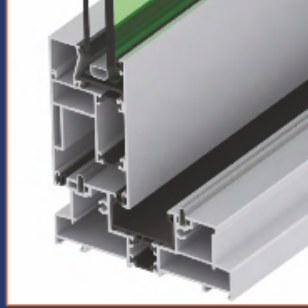

Silikon Profil ve Conta Çeşitleri

- PVC Pencere ve Kapı Sistem Contaları
- Alüminyum Kapı ve Pencere Sistem Contaları
- Çelik Kapı Contaları
- Ahşap Kapı ve Pencere Sistem Contaları
- Sineklik Contaları
- Dış Cephe Giydirme Contaları
- Dilatasyon Contaları
- Otomatik Kapı Contaları
- Dış Cephe Giydirme Profilleri
- Cam Profilleri



Onaylar

Lütfen sektör ve kullanım alanı için gerekli onaylara ait belgeler ve bu onaylara sahip ürünler hakkında detaylı bilgileri talep ediniz.

- Gıda Uyumu
- Medikal Kullanımlar
- İçme Suyu
- Otomotiv
- Diğer Sektörel ve Lokal Onaylar



Laboratuvar Altyapısı

Laboratuvarımızda;

- Elektriksel (izolasyon direnci, iletkenlik, yüksek gerilim vb.)
- Mekanik (çekme-kopma, sertlik, kalıcı deformasyon vb.)
- Fiziksel (reometri, viskosite, geometrik ölçümler) test cihazları ile eskitme öncesi ve sonrası kapsamlı analizler yapılabilmektedir.
- Farklı yaşlandırma testleri.
- Alev dayanım testleri



Teknik Destek

Ürün Geliştirme:

Elinizde üretmek istediğiniz bir ürün var ama hammadde seçiminde zorlanıyorsanız,

Teknik Spesifikasyonlar:

Uymanız gereken kritik bir teknik özellik veya şartname varsa,

Proses:

Kalıplama, enjeksiyon, ekstrüzyon, otoklav, kalenderleme, ne tür bir prosesiniz olursa olsun sıkıntılarınız varsa ve verimliliğinizi artırmak istiyorsanız,

Standartlar ve Sertifikasyon:

Hitap ettiğiniz sektörler ve müşterileriniz belirli standartlara uygunluk ve sertifikasyonu zorunlu tutuyorsa,

Kalitede Süreklilik:

Mekanik, fiziksel, kimyasal veya sadece sabit renk beklentileriniz varsa, istediğiniz kalitede ve özelliklerde ürün almakta zorlanıyorsanız,

Ürün ve Pazar Geliştirme:

Firmanız için yeni açılımlar; yeni ürünler, yeni prosesler, yeni pazarlar arıyorsanız.



Flyer Goldsmithing

Official Partner of Wacker Chemie AG

sol pro
Solution Provider

JEWELLERY CASTING & GOLDSMITHING

inoser
www.solpro-

Our Company SolPro, which is one of the biggest manufacturers of its field in Europe, has been giving consultancy and engineering services regarding production process and raw materials in various industries, and has been manufacturing tailor made products according to the specific needs of different industries for more than 15 years.

SolPro is the agent, distributor and the Partner Compounder of Wacker Chemie AG of Germany, besides it is the regional distributor for Elantas and Kömmerling / Polycyl / Cibond products.

For various industrial sectors, our company is able to support you with its wide product range and technical capacity in order to help you to choose the right materials for your production process and to develop value-added products, and will be pleased to serve you with the silicon-based finished products that we are producing and introducing as well.

Casting & Molding

- Ensures rapid prototyping and fast product design.
- Used for Metal, silver, gold, and such high strength casting.
- Provides cost advantage in both small and large scale production batches.
- Enables product designs in high detail.
- Availability to be processed both Compression and Manual Press.
- High Process efficiency. (The number of prints varies according to the surface width and weight of the product.)
- Etc.



Fields of Application

- Jewellery and Gold Molding
- Bipoterie Industry
- Medical Products

Main Products and Services

- Compounds for Gold Casting
- Compounds for Zinc Molding
- Compounds for Lead Casting
- Crucible Seals
- Wax
- Putty Compounds
- RTV Silicone Rubber

Advantages

- Availability in Shore Hardness between 45 - 70 Sh A
- High tensile, rupture and tear strength
- Adjustable vulcanization time acc. to the process
- Wide range of colors
- Product offer for each and every step of the process
- Fast casting in high numbers in spite of the reasonable prices (Very High Price vs Performance ratio)

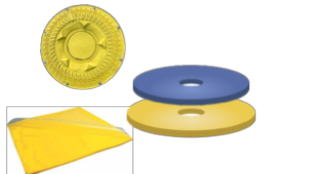

“

WACKER CREATING TOMORROW'S SOLUTIONS

PARTNER COMPOUNDER OF WACKER CHEMIE AG

September 16, 2011

SOLPRO Danışmanlık Kimya Sanayi Tic. Ltd. Şti.

signed a Partnership Agreement with Wacker Chemie AG

to produce and sell high-quality compounds of high temperature vulcanizing silicones and is entitled to label them "Based on ELASTOSIL™".

ELASTOSIL™ is a registered trademark of Wacker Chemie AG

Dr. Bernd Pachter, Vice President Engineering Silicones

Axel Schmitt, Director Rubber Solutions Engineering Silicones

Valid until December 31, 2014

”

Our Company SolPro, which is one of the biggest manufacturers of its field in Europe, has been giving consultancy and engineering services regarding production process and raw materials in various industries, and has been manufacturing tailor made products according to the specific needs of different industries for more than 15 years.

SolPro is the agent, distributor and the Partner Compounder of Wacker Chemie AG of Germany; besides it is the regional distributor for Elantas and Kömmerling / Polycil / Cilbond products.

For various industrial sectors, our company is able to support you with its wide product range and technical capacity in order to help you to choose the right materials for your production process and to develop value-added products, and will be pleased to serve you with the silicon-based finished products that we are producing and introducing as well.

Casting & Molding

- Ensures rapid prototyping and fast product design.
- Used for Metal, silver, gold, and such high strength casting.
- Provides cost advantage in both small and large scale production batches.
- Enables product designs in high detail.
- Availability to be processed both Compression and Manual Press.
- High Process efficiency. (The number of prints varies according to the surface width and weight of the product.)
- Etc.

Fields of Application

- Jewelry and Gold Molding
- Bijouterie Industry
- Novelty Products

Main Products and Services

- Compounds for Gold Casting
- Compounds for Zinc Molding
- Compounds for Lead Casting
- Crucible Seals
- Wax
- Putty Compounds
- RTV? Silicone Rubber



Advantages

- Availability in Shore Hardness between 45 - 70 Sh A
- High tensile, rupture and tear strength
- Adjustable vulcanization time acc. to the process
- Wide range of colors
- Product offer for each and every step of the process
- Fast casting in high numbers in spite of the reasonable prices (Very High Price vs Performance ratio)

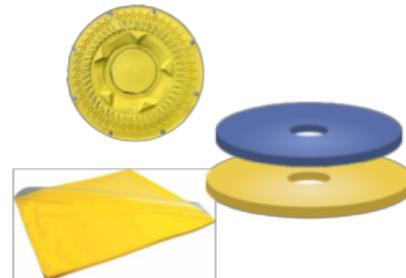

Compliance And Approvals

Please see the documentation for the approvals for the sector and the area of use and request detailed information about our products.

- Human health compliance
- Approval for medical use
- Drinking water compliance (WRAS)
- Compliance and approvals specific to the automotive sector
- REACH, RoHS and CE Compliance
- And different approvals upon request

Laboratory Infrastructure

In our laboratory, we have the capability to test;

- Electrical (insulation resistance, conductivity, high voltage, etc.) properties
- Mechanical (tensile-rupture, hardness, permanent deformation, etc.) properties
- Physical (rheometer, viscosity, geometric measurements) Before and After extensive Analysis,
- Different aging,
- Flame resistance,
- And many other tests, thanks to our experienced staff and extensive portfolio of test equipment.

Technical Support

Product Development:

If you have a product that you want to produce, but you have difficulty in Choosing raw materials,

Technical Specs:

If you have a critical technical specification or specification,

Process:

If you have problems with molding, injection, extrusion, autoclave, calendaring or whatever process you want, and want to increase your productivity,

Standards and Certification:

If the sectors you are addressing and your customers require compliance and certification to certain standards,

Continuity in Quality:

If you have mechanical, physical, chemical or only constant color expectations, if you have difficulty in obtaining the desired quality and specifications,

Product and Market Development:

New openings for or company if you are looking for new products, new processes and new markets.

